

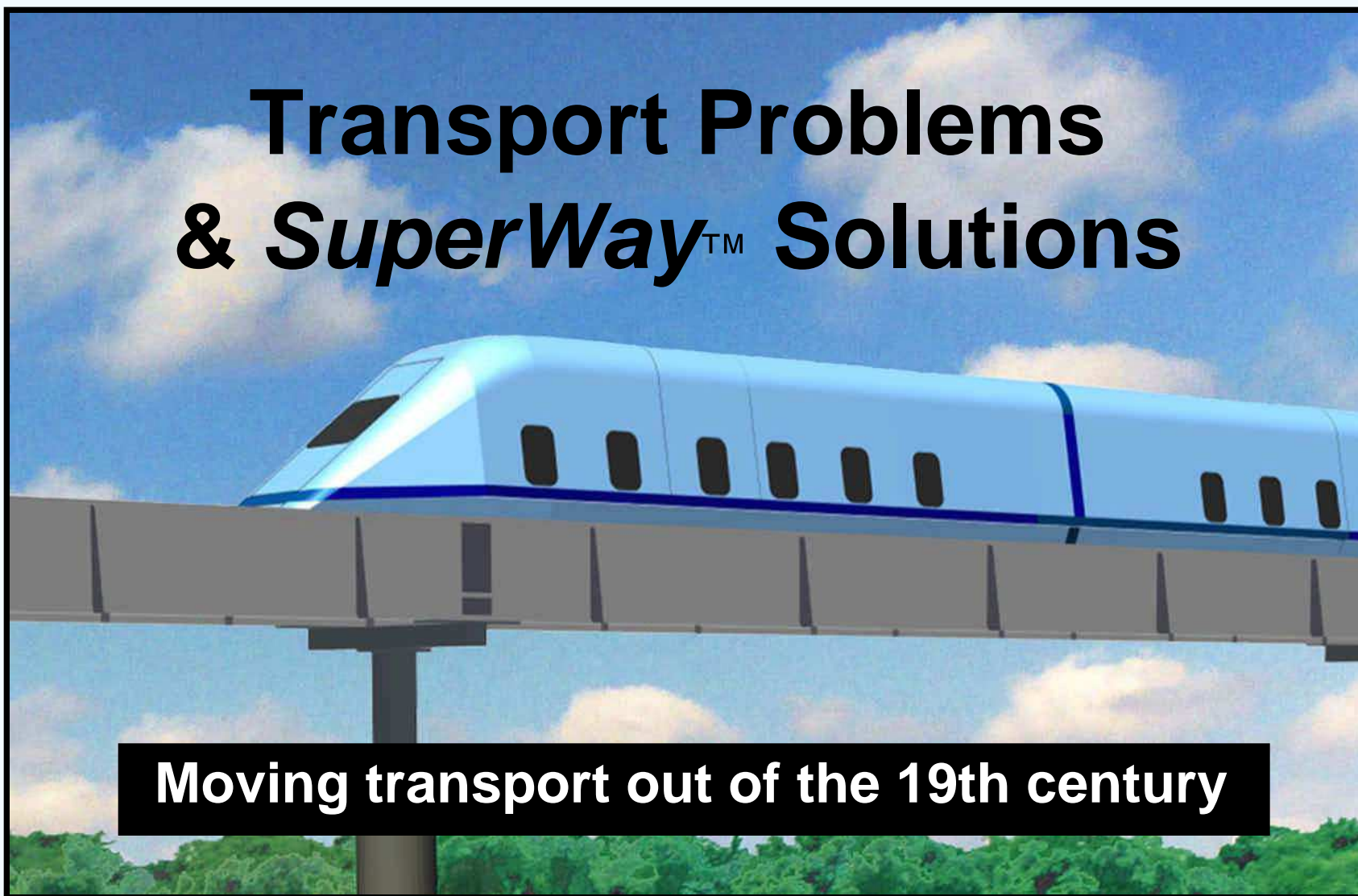

Transport Problems & *SuperWay*TM Solutions



Moving transport out of the 19th century

ROAM Transport Systems, Fort Worth, Texas

SuperWay, MegaWay, CargoWay, MicroWay, CarLiner, CarFerry, SkyCoach, CargoLiner, WhisperLiner, MegaLiner, & PersonLiner are trademarks of ROAM Transport Systems
U.S. PATS. 6,039,135, 6,401,625, 6,435,100, 6,615,740, 6,742,458, 6,834,595, 6,837,167, & 7,926,425 B2
OTHER U.S. & INTERNATIONAL PATENTS PENDING

ROAM® is a registered trademark of XIP,LLC licensed to ROAM Transport Systems

© Reg. U.S. Pat. & Tm. Off.

ROAM graphics & photos

5-15-15

1

RMW-GEN-12

Current Picture

Critical problems need solutions

- **Passenger rail *can't do it!***
 - Too costly for U.S. – *Plus we aren't Europe*
- ***Saturated* roads – More roads too costly**
- **Heavy trucks *pulverizing pavement***
- ***Critical* air pollution**
 - Plus budget-busting gas & diesel costs
- **New & better ways are essential!**

Real *SuperWay*[™] Solutions Now!

- **Urban & high-speed services**
 - Essential 24 / 7, door-to-door service
 - Retains full automobile flexibility
- **Local & high-speed cargo service**
 - Reduced shipping cost at higher speed
 - Fewer pavement–busting heavy trucks

Without more expensive roads & rail

Freeway to *SuperWay* Shift

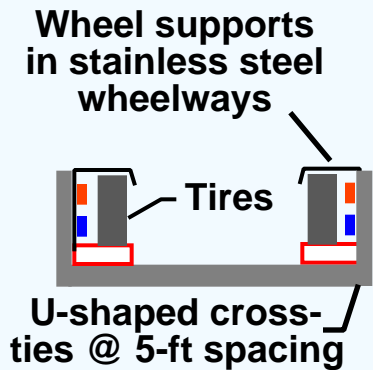
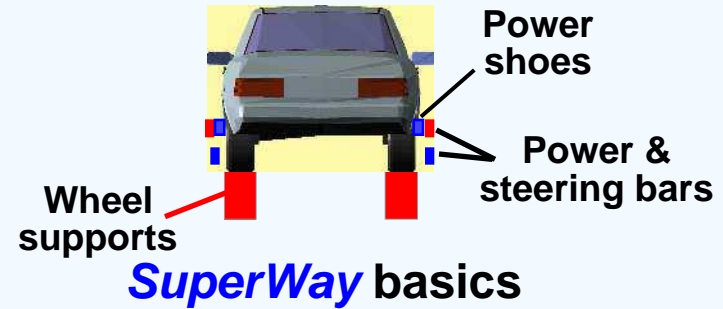
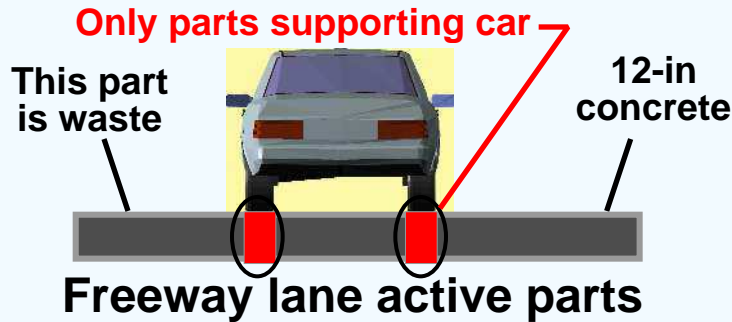

Use steel road & efficient shaping

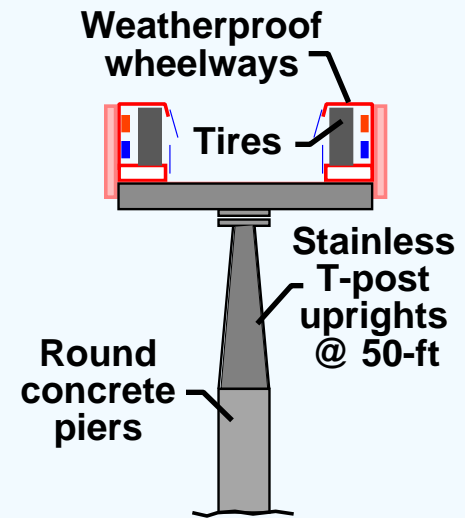
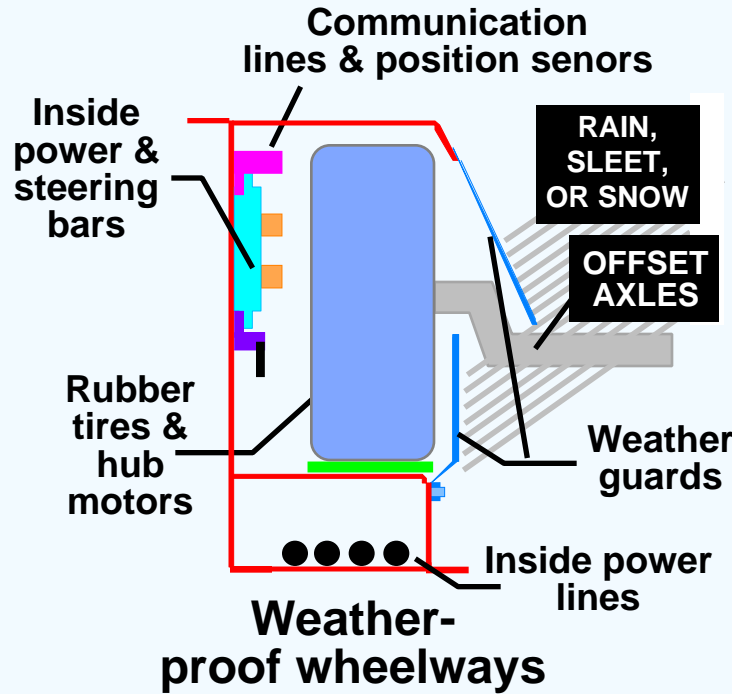

Factory-built, elevated, electrified, *SuperWay*

Low-cost, electrified, automated super-freeway

Low Risk, Phased Solutions

- **Phase I - *Affordable & near-term*** (42 months)
(Ultra-light, manually controlled trains)
 - High-speed inter-city passenger & cargo service
 - Urban & commuter services
 - Marine heavy cargo containers
- **Phase II - *Automate trains*** (4 years)
 - Reduced cost
 - More frequent schedules
- **Phase III - *Automate cars*** (4 to 10 years)
 - Personal & group transport – Urban & inter-city
 - Automated cargo carriers

Major *SuperWay* Advantages

- **Far lower cost** - Use road & street ROW
 - Inter-city ultra-light service – **20%** of rail cost
 - Urban ultra-light transit – **20 to 25%** of LRT cost
- **Far shorter time to service**
 - 30 to 40% of time for other solutions
- **Local or state funding** – **No federal funds!**
 - Revenue bonds and local / state funds
(*Self-sustaining and profitable*)
- **Future growth** - Impossible with other systems

New *MegaWay* High-speed & Commuter Solutions



Practical & affordable solutions available now!

Near-term at 20% of rail cost!

MegaWay™ High-speed Passenger Service

WhisperLiner™ – Inter-city Service

- Whisper-quiet smooth ride
- First-class airliner seating
- Airliner-type lavatories
- Grade-separated for safety
- Safe, derail-proof design
- All-weather service
- **120-mph** non-stop travel



120-mph *WhisperLiner* train along Interstate

- Service in 48 months
- All-electric operation
- Interstate right-of-way
- Ultra-low noise - rubber tire
- Train crew manual control
- **Affordable cost**

WhisperLiner™ – Passenger Coaches

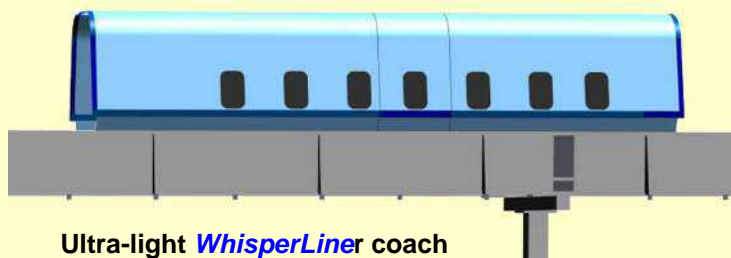

Ultra-light *WhisperLiner* coach

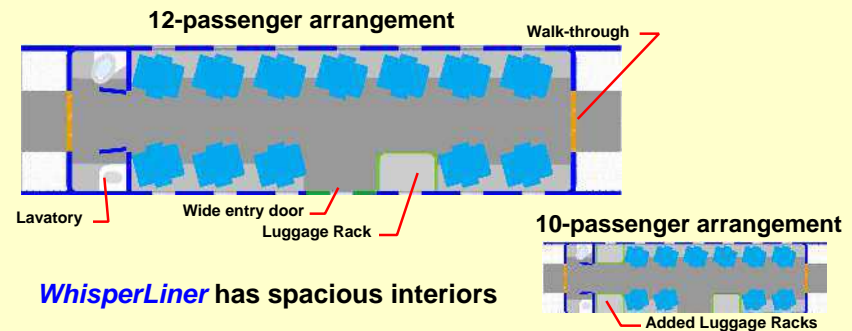

WhisperLiner has spacious interiors

MegaWay™ high-speed CarLiner™

CarLiner™ – Inter-city Passenger & Automobile Service

WhisperLiner service plus
– Take along your car!

- Park car as you board train
- Car available upon arrival
- Cars ride on car-ferries



120-mph CarLiners share same guideway

- Passengers park car on car ferries & then board coaches
- Passengers enter & drive their cars from ferries at destination

CarLiner™ – Car-ferries

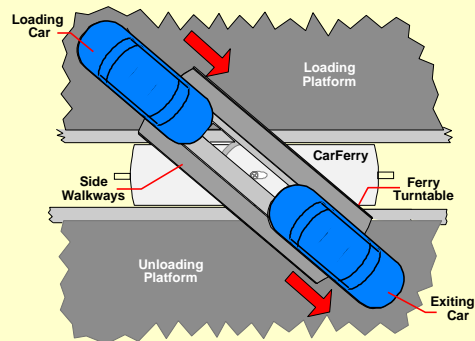

Rapid car loading & unloading at stations

Occupants walk to train coaches

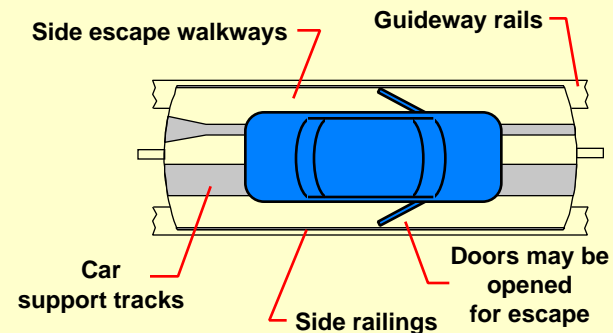

MegaWay™ High-speed CargoLiner™

CargoLiner™ – Inter-city Containerized Cargo Service

- 120-mph cargo service
- Closed cargo containers
- Three tons / carrier
- Rapid container handling
- Truckable containers

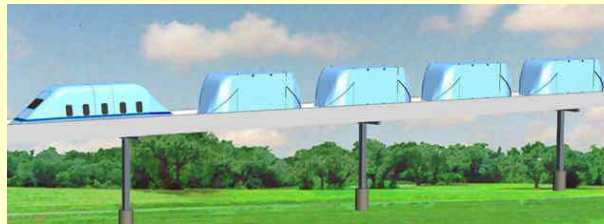

CargoLiners carry special closed containers

- Trains use same guideway as *WhisperLiners*
- Streamlined for low drag
- De-rail proof design
- Power for refrigeration
- Train crew manual control

CargoLiner™ Cargo Containers

- Upper lift points for loading
- Handle with forklift
- 1-1/2 and 3 ton containers
- Flat bed truck transport
- Closed containers

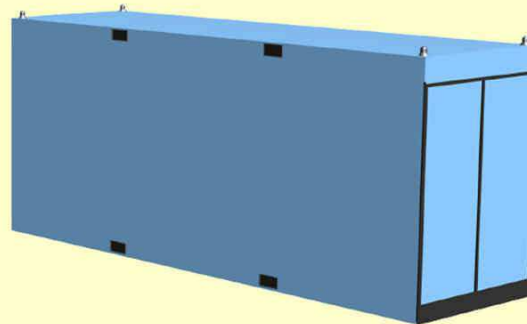

- Light weight
- Handle standard pallets
- Stackable
- Power connections
- Refrigeration available

Ultralight Commuter *MegaWay CarTrain*[™] 85-mph service in your car or in train coach at low cost

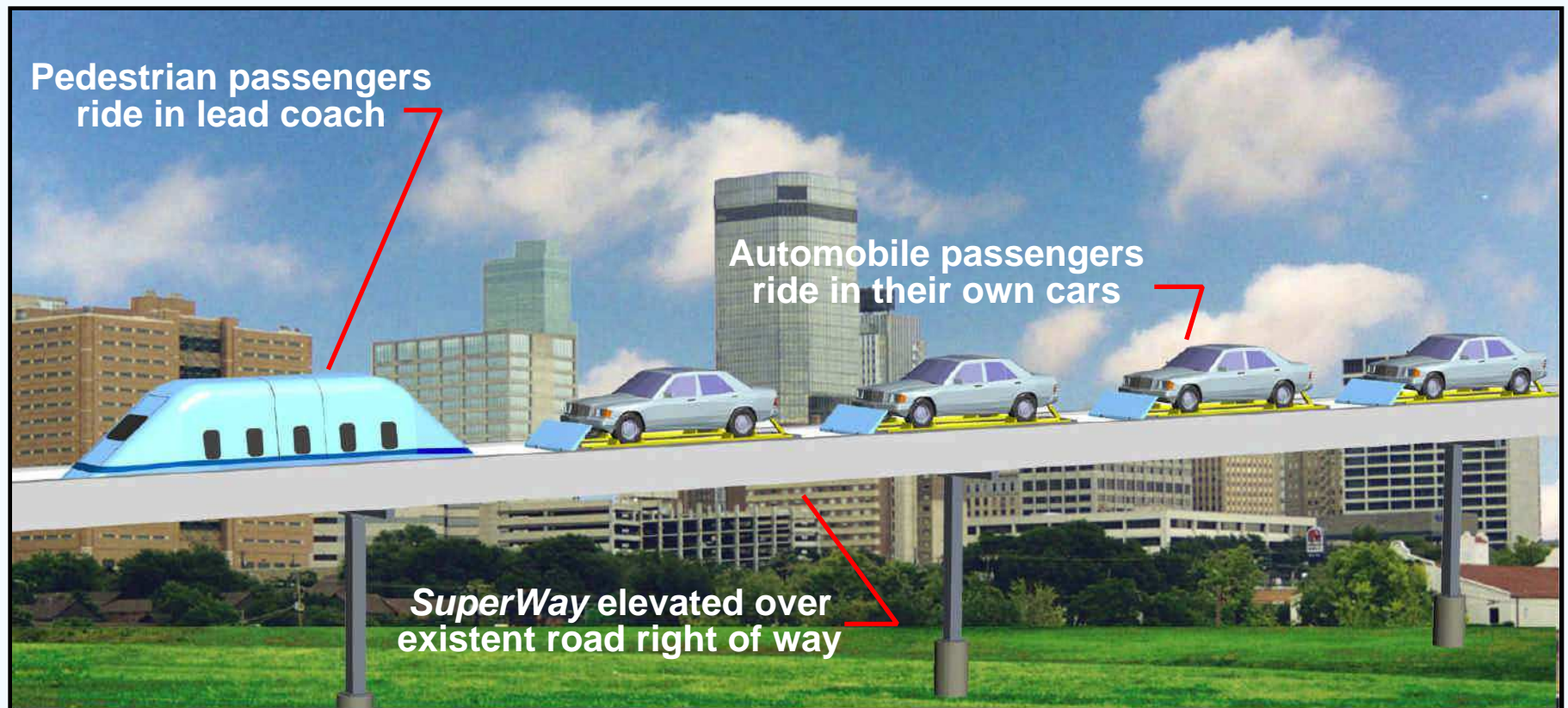

Ultralight *MegaWay* commuter *CarTrain* on elevated *SuperWay*
Skycoach[™] & *CarFerries*[™] in single train – A “last mile” solution
Automobile passengers **never leave their car for entire commute!**

Ultralight *MegaWay* Commuter

*WhisperLiner*TM – Commuter Passenger Service

- Whisper-quiet smooth ride
- First-class airliner seating
- Optional lavatories
- Grade-separated for safety
- Safe, derail-proof design
- All-weather service
- **85-mph** non-stop travel



85-mph *WhisperLiner* train along Interstate

- Service in 48 months
- All-electric operation
- Use Interstate right-of-way
- Ultra-low noise
- Train crew manual control
- Affordable cost

*WhisperLiner*TM – Passenger Coaches

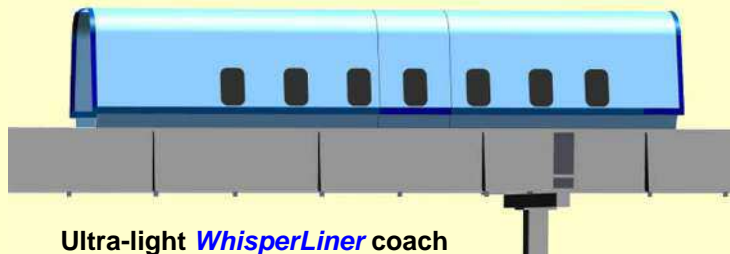

Ultra-light *WhisperLiner* coach

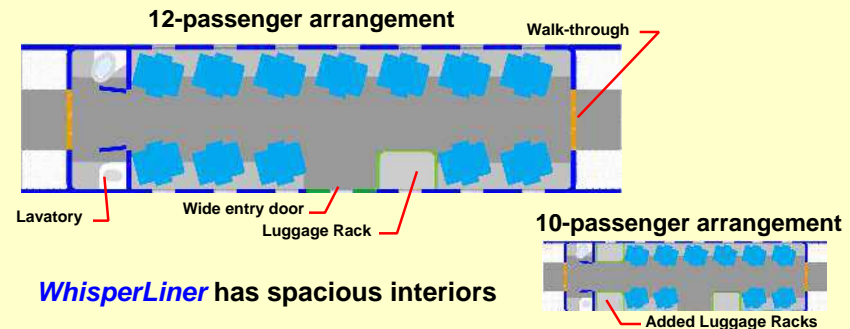

WhisperLiner has spacious interiors

Up to 15 seated passengers per car!

MicroWay Mass Transit Solutions

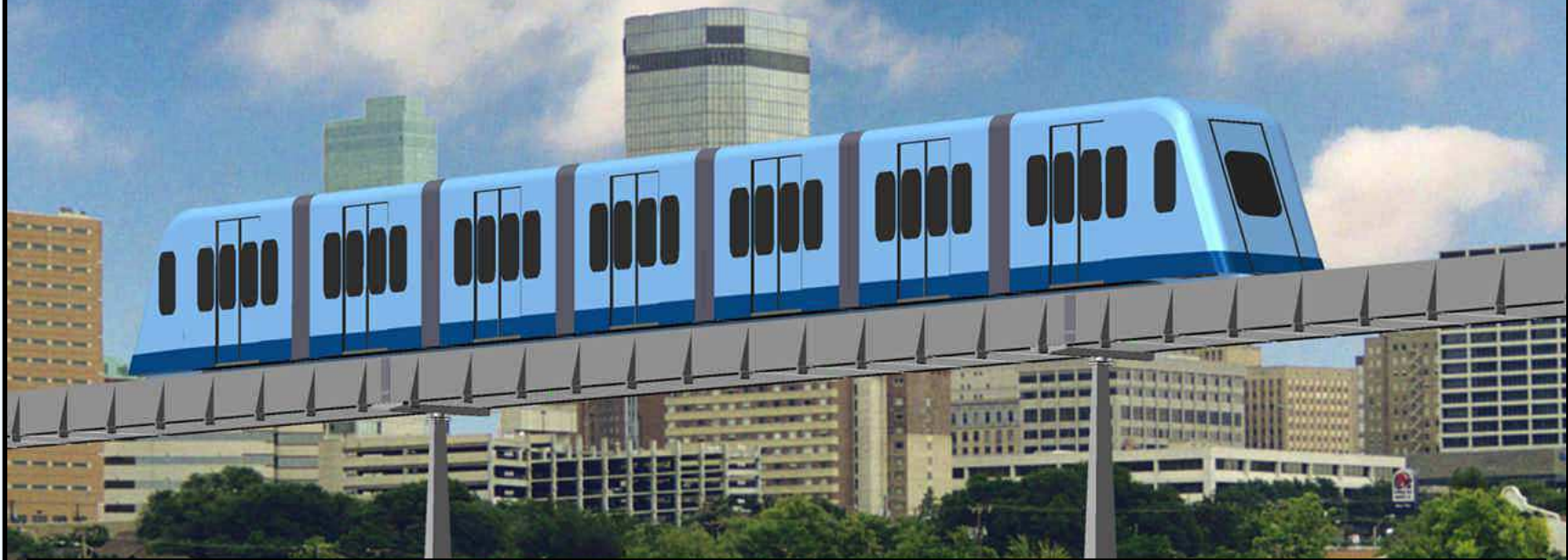

Superior performance to light rail in small space & at lower cost

MicroWay SkyCoach mass transit train on elevated *SuperWay*
(Mechanically-coupled train operated by on-board motorman)

Near-term at 20% of light rail system cost

MicroWay Skycoach™ mass transit service

MicroWay – Affordable urban mass transit

- Whisper-quiet smooth ride
- ALL passengers seated
- Elevated for safety
- Safe, derail-proof design
- All-weather service
- 65-mph top speed

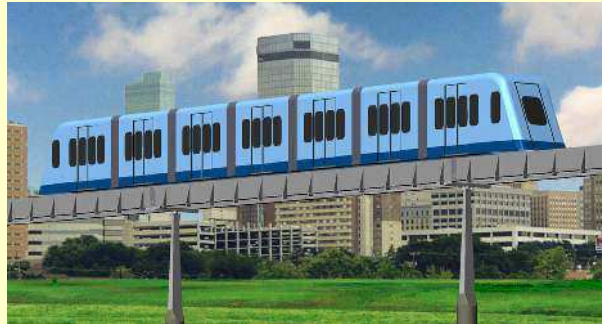

65-mph ultralight MicroWay mass transit train

- Service in 48 months
- All-electric operation
- Use street right-of-way
- Ultra-low noise
- Motorman manual control
- Ultra-low 20% LRT cost
- 6X LRT capacity

MicroWay – Small, Ultra-light, comfortable SkyCoaches

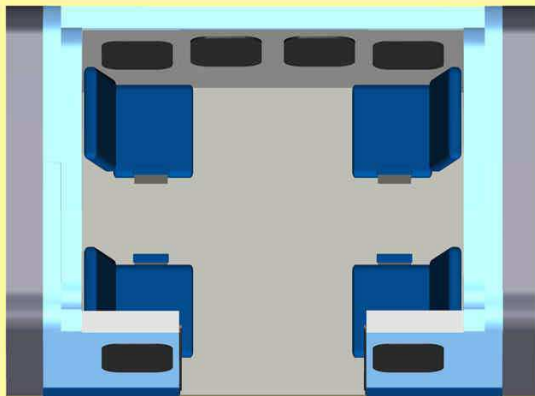

MicroWay SkyCoach Interior

- 3% LRT car weight
- Self-propelled
- Long-life stainless
- Rubber tires
- Air suspension
- Air conditioned
- 13-passenger cars

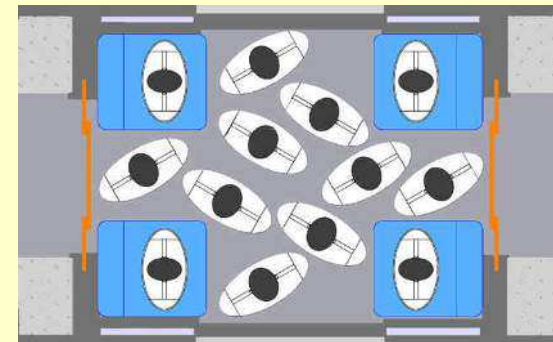

MicroWay coaches carry up to 13 and seat from four to six passengers

20 to 30-car trains – 260 to 390 passengers per train

MegaWay SkyCoach™ Mass Transit

Trains of small & lightweight, mechanically-coupled cars



30-passenger cars

- 15-ft long cabin
- 18-ft total length



Cars allow standing passengers

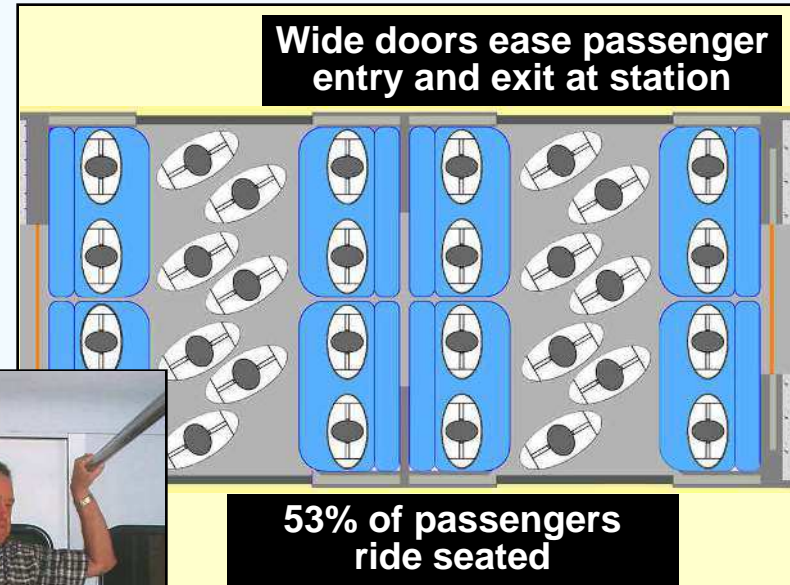

25-sec dwell times

- 11 to 16-car trains
- 330 to 480 passengers per train

***SkyCoaches* offer Safe Escape**

Unaided escape for all (including wheelchairs) without rescue personnel



- Full-height escape doors in ends of coaches
- Open-mesh escape walkway between rails
- Covered electric bars



Upward view through walkway

Small, Low Cost, Factory-built *SuperWay*

Fast, bolt in place installation

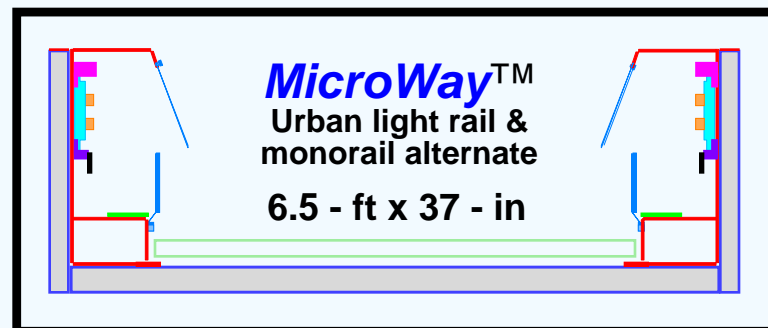
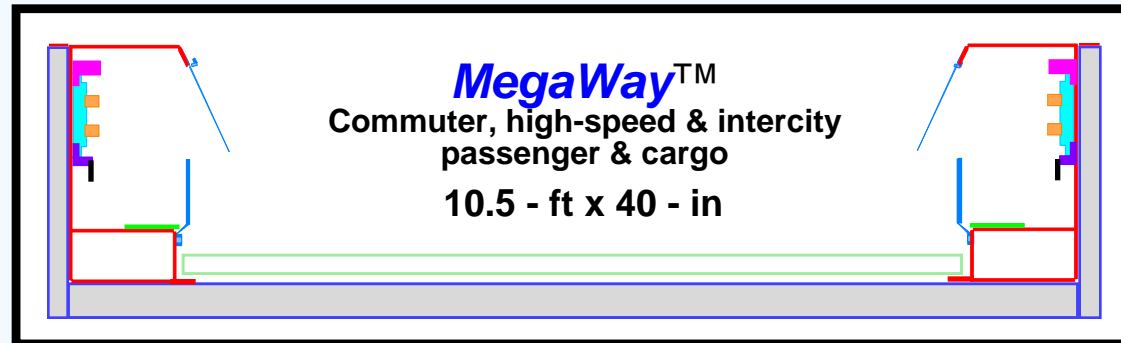

SuperWay cross-sections

- Over street rights-of-way – No more land or earth moving projects
- Mass-produced, factory-built sections – *fast on-site intatallation*

MegaWay – Urban “Last Mile” Solution



Automated *CarFerry*™ provides personal conventional automobile service on same guideway

Future Urban “Last Mile” *MicroWay* Solutions

Fully Automated, 24/7 services in 52 Months



Small, 4-passenger urban
Personal Automated Transit
cars



Automated urban *CarFerry*
service for small & mid-size
automobiles

Future high-speed, inter-city services

MegaRail photos & graphics

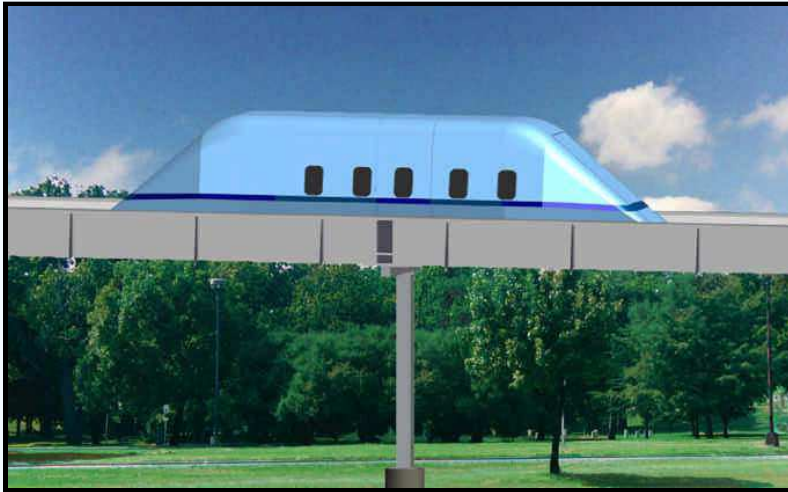

Automated **MegaWay** eight to nine-passenger **MegaLiner™**
non-stop, 120-mph, high-frequency, 24-hr group service

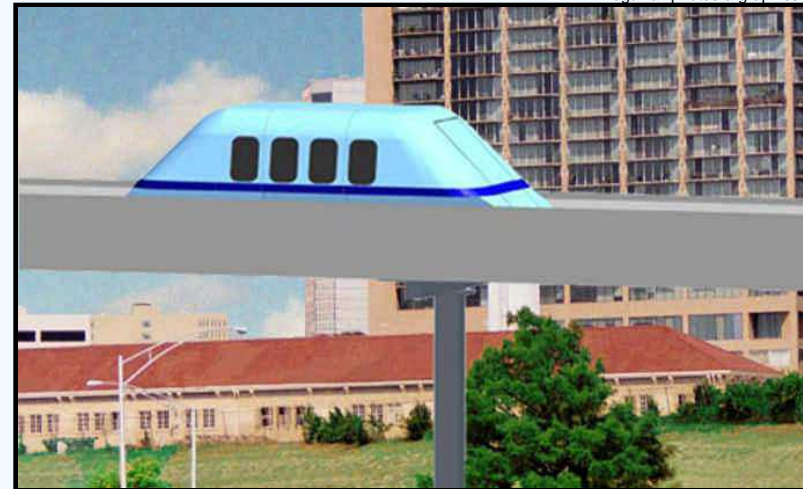

MegaWay Four to six-passenger **PersonLiner™**
non-stop, 120-mph, on-call, 24-hr personal service

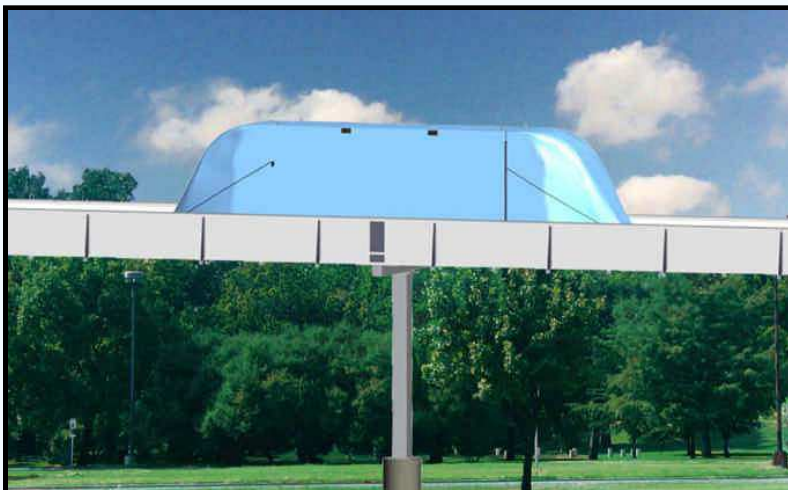

MegaWay cargo car on **SuperWay** moves
containers at speeds up to 120-mph
U.S. Patent 6,615,740

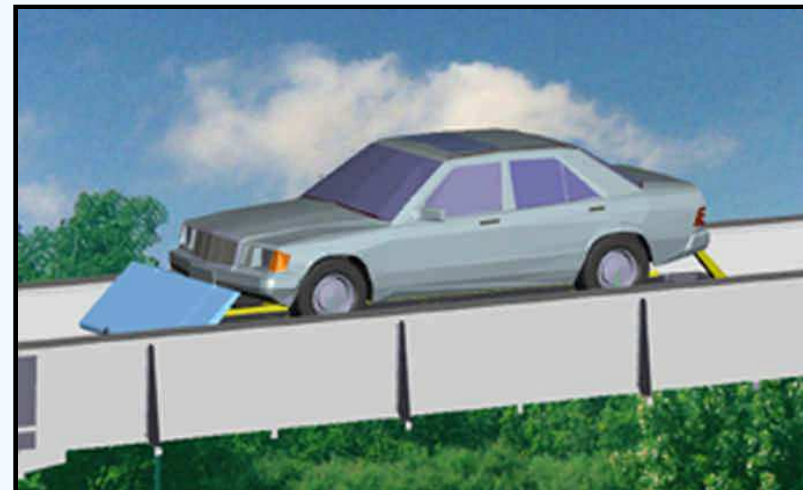

MegaWay Carferries carry standard cars
with driver and passengers inside
U.S. Pat. 6,435,100

Automated Heavy *CargoWay*TM

*CargoWay*TM – Non-stop Heavy Containerized Cargo Service

- 75-mph cargo service
- Standard 40-ft containers
- 65,000-lbs per carrier
- Rapid container handling
- Truck-type grade capability
- Electrically powered
- Self-propelled carriers
- Quiet, rubber tire operation

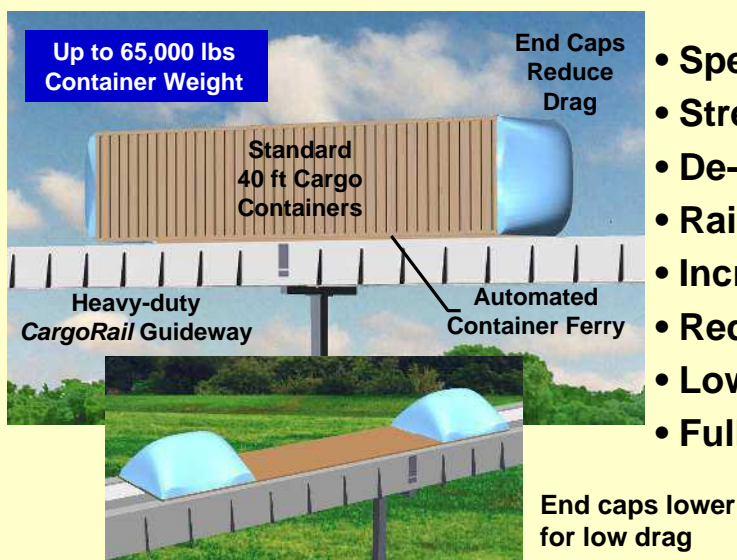

- Special cargo guideway
- Streamlined for low drag
- De-rail proof design
- Railroad or highway ROW
- Increase railway capacity
- Reduce truck traffic
- Low-cost guideways
- Fully automated control

U.S. Pat. 6,615,740

Initial automated service within 4 years

Uses existent rights of way

Dualmode *SuperWay* & Street *CargoTram*TM

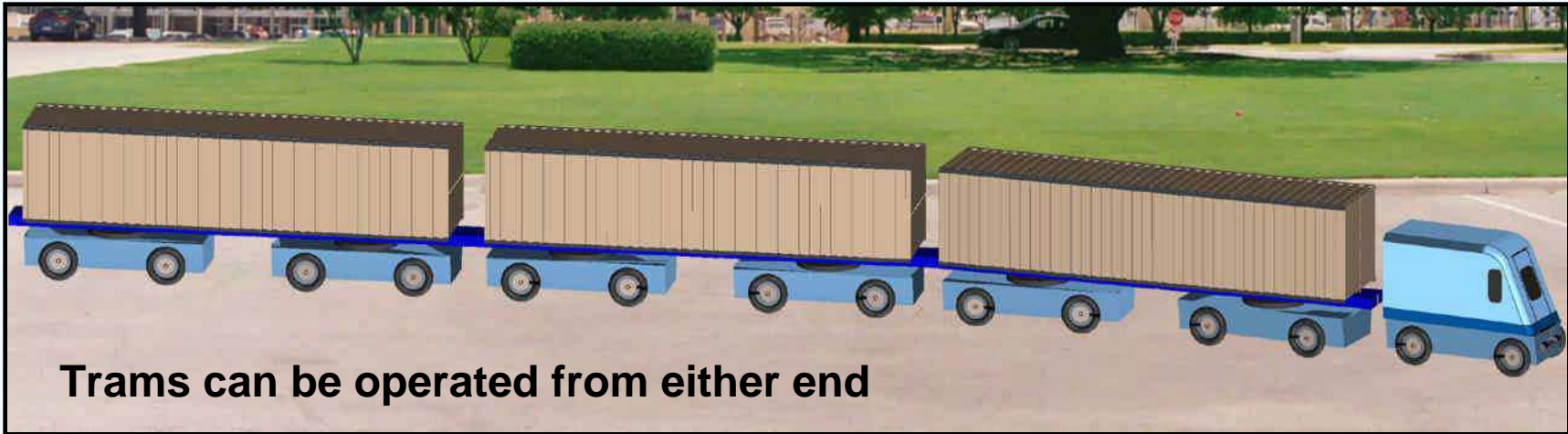

U.S. PAT. 7,926,425

Dualmode *CargoWay*TM *CargoTram* operates both as *SuperWay* train and on ground as lead vehicle *exact path following* hybrid tram

Use between seaports and railway intermodal centers

ROAM
Ultra-light Technology
Basis

Unique solutions
using innovative, but ***low-risk***
application of
off-the-shelf, **proven technology!**

U.S. PATS. 6,039,135, 6,401,625, 6,435,100, 6,615,740, 6,742,458, 6,834,595, 6,837,167, & 7,926,425 B2

SuperWay – Self-funding Alternate that Works

- Elevated steel **Superway** over any public right of way
 - *Electrically-powered – Low pollution*
 - Rubber-tired wheels in enclosed wheelway tubes
 - Silent service
 - All-weather service
 - Up and down hills
 - Low-cost
 - Small, separated wheelway tubes for low visual obstruction
- Little new right of way – Minimum land use
- **Serves ALL users – TAKES TRAFFIC OFF ROADS!**



Minimal sky blockage – No wide elevated conventional train shadows



Open-center **Superway** casts small shadow

U.S. Patent 6,837,167

Low risk – Current, proven technology!

Unique *SuperWay* Features

Weather-proof wheelways

Essential Feature for Automated Operation

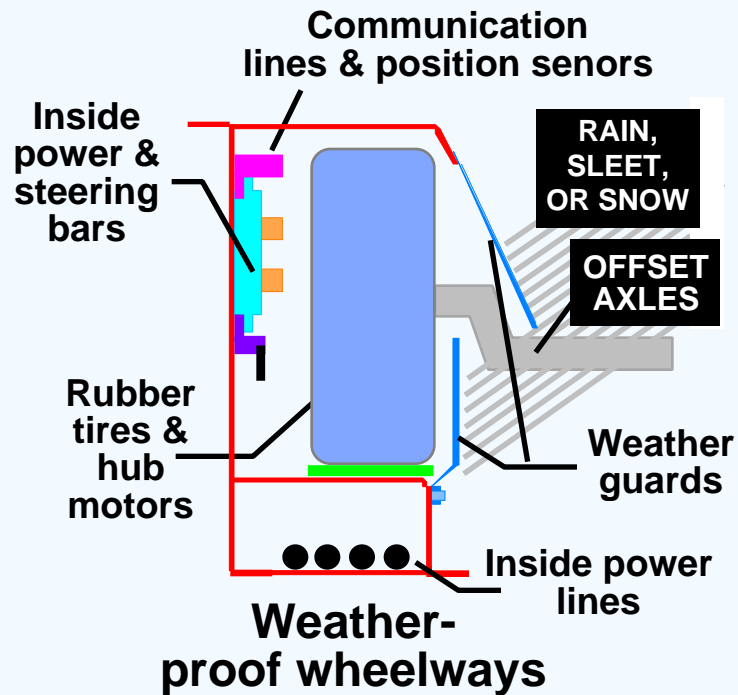

U.S. Pat. 6,039,135

Systems operate under all weather conditions

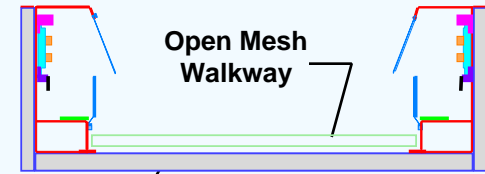

U.S. Pat. 6,837,167

Open *SuperWay* minimizes visual mass & light blockage to ground

***SuperWay* is elevated above surface activities**

17.5 FEET

GROUND SURFACE

Factory-built, Modular *SuperWay*™ Stations

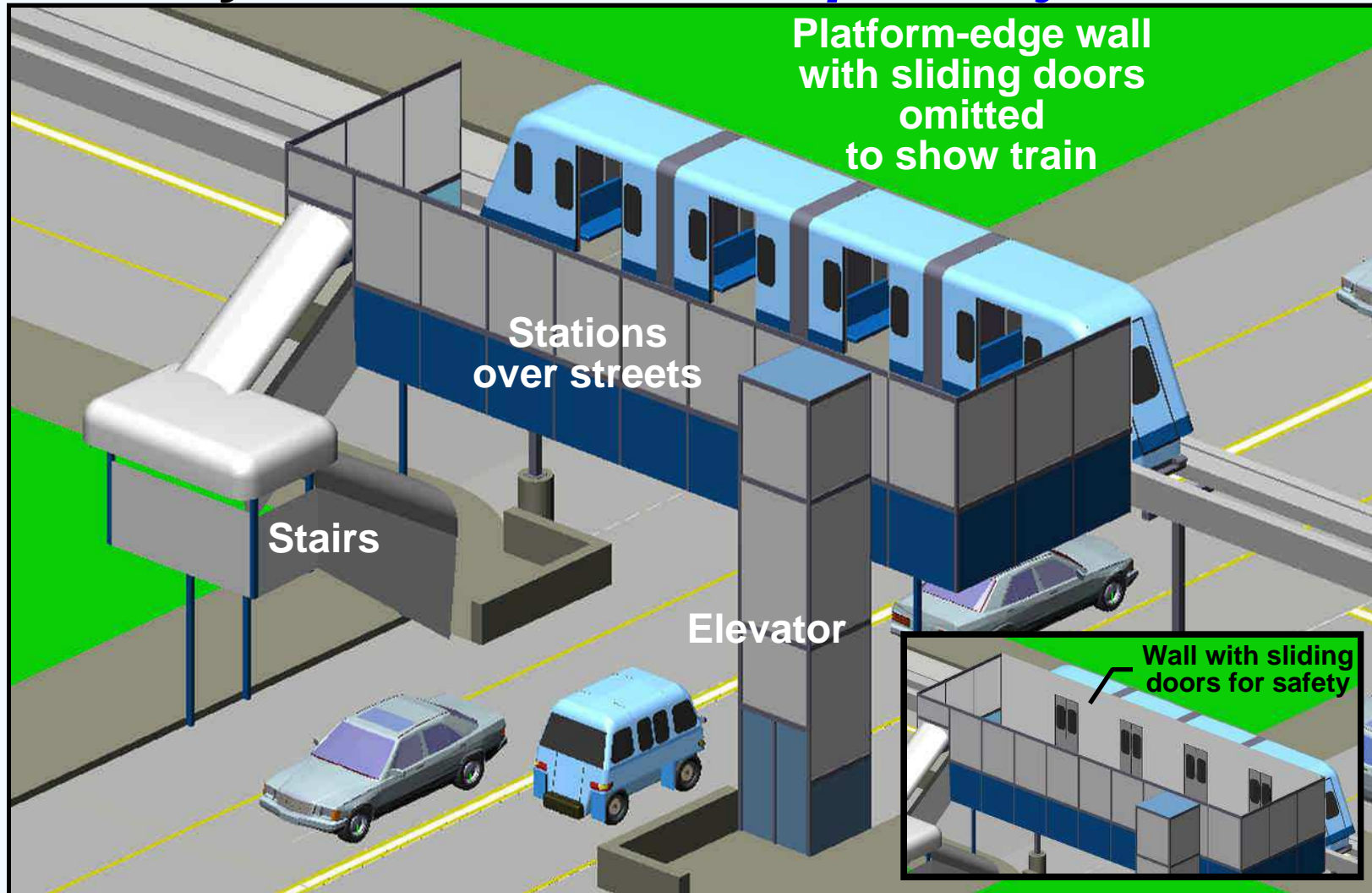

MicroWay mass transit train at elevated, over-street *SuperWay* station

- Low-maintenance stainless-steel
- Low cost
- Minimum street impact

Technology Summary

Unique, patented new combination of proven technology (8 patents)

Enclosed stainless-steel wheelways - US Pat. 6,039,135

- Simple welded steel factory fabrication
- Standard power rails

Flat-free tires – Current technology

Permanent-magnet electric motors

- Current commercial motor technology
- Electric motor wheels – Some electric cars

Car-based steering & switching

- Smooth *non-contact* electronic steering
- Switching – By cars as on conventional freeway!

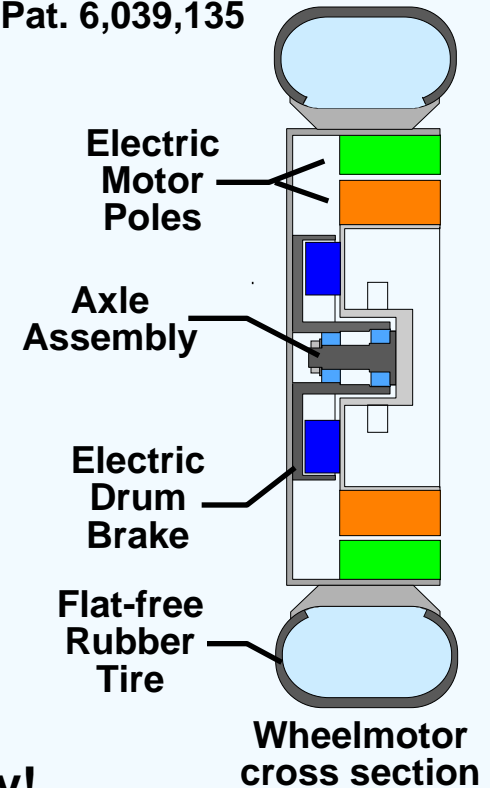

Only the combination & SuperWay are new!

ROAM

Advantages Summary

Proven Industry Team

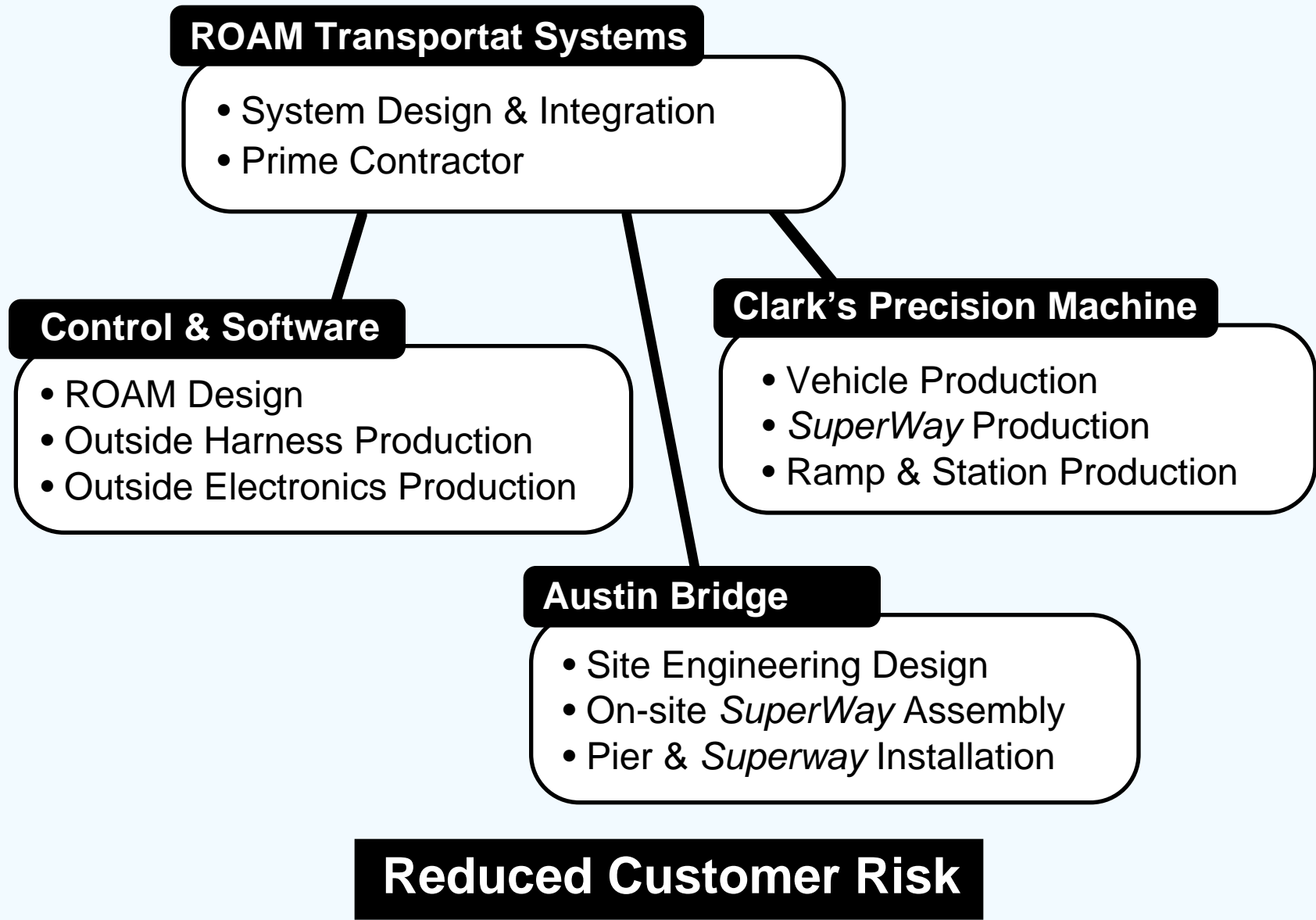

ROAM - *Low-risk* Solutions

Revolutionary but entirely off-the-shelf, proven technology

- **First systems use manual train control**
Control proven in transit and railroad systems
- **No exotic technologies**
All technologies proven in transit and auto systems*

* Future automated systems also use some aircraft proven technology

• Low Cost
• Low Tech
• Low Risk

Environment-friendly Solutions

No adverse environmental impacts - We make it better!

- **No Increased Air or Water Pollution** - *Electric power*
 - *Pollution reduced* by taking cars, trucks & buses from roads
- **No Added Traffic Noise or Freeway Lights**
 - *Whisper-quiet* system makes almost no noise
 - Current traffic noise reduced
 - No lights needed on automated guideways
- **No Earth Moving or Changes to Drainage**
 - Elevated over road/street right-of-way
- **Minimum Disruption of Surface Activities**
 - No blocked streets or traffic stops • Night installation
- **Low Visual Cross-section** - *Minimal shadowing*



401 West Jim Wright Freeway, Suite113

Mail Address

**P. O. Box 121728
Fort Worth, Texas 76121**

(817) 738-9507

FAX (817) 367-2373

contact@roamtrans.com

www.roamtrans.com

Revolutionary, High-speed, Multi-user
21st Century Transport!

- *Unprecedented* level of service
- Low transportation user costs

**Near-term & affordable solution to
traffic & air pollution problems**

ROAM® Transport Systems, Fort Worth, Texas

SuperWay, MegaWay, CargoWay, MicroWay, CarLiner, CarFerry, SkyCoach, CargoLiner, WhisperLiner, MegaLiner, & PersonLiner are trademarks of ROAM Transport Systems

U.S. PATS. 6,039,135, 6,401,625, 6,435,100, 6,615,740, 6,742,458, 6,834,595, 6,837,167, & 7,926,425 B2

OTHER U.S. & INTERNATIONAL PATENTS PENDING